

# DORMITORIO MATRIMONIO

# DONALD 01-A



DORMITORIO MATRIMONIO

107,74 puntos



Cabecero matrimonio

49,8x247x3,2

Puccini-andersen

1

19,19



Mesita de noche 2 cajones

53,8x44,6x33,5

Puccini-andersen

2

22,14



Sinfonier 5 cajones

108x60x37,8

Puccini-andersen

1

44,27

Combinaciones de colores disponibles:

ANDERSEN-PUCCINI



ANDERSEN-GRAFITO

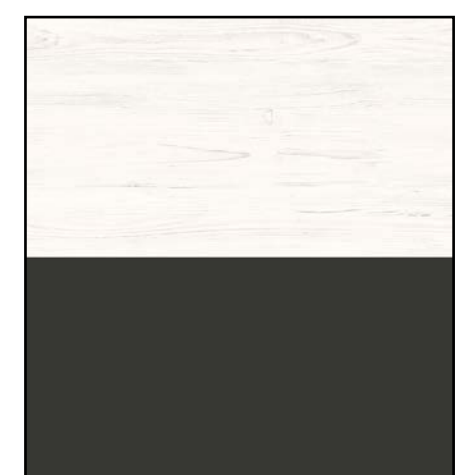

PUCCINI-ANDERSEN



PUCCINI-GRAFITO



# DONALD DORMITORIO MATRIMONIO



## DONALD 01-B



 DORMITORIO MATRIMONIO 107,74 puntos



## DONALD 01-C



 DORMITORIO MATRIMONIO 107,74 puntos

## DONALD 01-D

 DORMITORIO MATRIMONIO 107,74 puntos

	DESCRIPCIÓN	MEDIDAS	COLOR	UNID.	PUNTOS/UNID.
	Cabecero matrimonio	49,8x247x3,2	Andersen-puccini	1	19,19
	Mesita de noche 2 cajones	53,8x44,6x33,5	Andersen-puccini	2	22,14
	Sinfonier 5 cajones	108x60x37,8	Andersen-puccini	1	44,27



	DESCRIPCIÓN	MEDIDAS	COLOR	UNID.	PUNTOS/UNID.
	Cabecero matrimonio	49,8x247x3,2	Andersen-grafito	1	19,19
	Mesita de noche 2 cajones	53,8x44,6x33,5	Andersen-grafito	2	22,14
	Sinfonier 5 cajones	108x60x37,8	Andersen-grafito	1	44,27

	DESCRIPCIÓN	MEDIDAS	COLOR	UNID.	PUNTOS/UNID.
	Cabecero matrimonio	49,8x247x3,2	Puccini-grafito	1	19,19
	Mesita de noche 2 cajones	53,8x44,6x33,5	Puccini-grafito	2	22,14
	Sinfonier 5 cajones	108x60x37,8	Puccini-grafito	1	44,27

# DORMITORIO MATRIMONIO

# DONALD 02-A

	<b>DORMITORIO SIN ARMARIO</b>	<b>63,47 puntos</b>
	<b>DORMITORIO COMPLETO</b>	<b>171,50 puntos</b>

	DESCRIPCIÓN	MEDIDAS	COLOR	UNID.	PUNTOS/UNID.
	Cabecero matrimonio	49,8x247x3,2	Andersen-grafito	1	19,19
	Mesita de noche 2 cajones	53,8x44,6x33,5	Andersen-grafito	2	22,14
	Armario 3 puertas 2 cajones	207,6x130x50	Andersen-grafito	1	108,43

### Combinaciones de colores disponibles:

ANDERSEN-PUCINI



ANDERSEN-GRAFITO

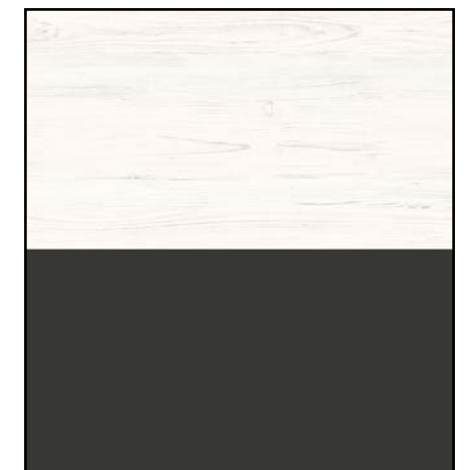

PUCINI-ANDERSEN



PUCINI-GRAFITO



# DONALD DORMITORIO MATRIMONIO



## DONALD 02-B

	DORMITORIO SIN ARMARIO	63,47 puntos
	DORMITORIO COMPLETO	171,50 puntos







## DONALD 02-C

	DORMITORIO SIN ARMARIO	63,47 puntos
	DORMITORIO COMPLETO	171,50 puntos





## DONALD 02-D

	DORMITORIO SIN ARMARIO	63,47 puntos
	DORMITORIO COMPLETO	171,50 puntos

	DESCRIPCIÓN	MEDIDAS	COLOR	UNID.	PUNTOS/UNID.
	Cabecero matrimonio	49,8x247x3,2	Andersen-puccini	1	19,19
	Mesita de noche 2 cajones	53,8x44,6x33,5	Andersen-puccini	2	22,14
	Armario 3 puertas 2 cajones	207,6x130x50	Andersen-puccini	1	108,43

	DESCRIPCIÓN	MEDIDAS	COLOR	UNID.	PUNTOS/UNID.
	Cabecero matrimonio	49,8x247x3,2	Puccini-andersen	1	19,19
	Mesita de noche 2 cajones	53,8x44,6x33,5	Puccini-andersen	2	22,14
	Armario 3 puertas 2 cajones	207,6x130x50	Puccini-andersen	1	108,43

	DESCRIPCIÓN	MEDIDAS	COLOR	UNID.	PUNTOS/UNID.
	Cabecero matrimonio	49,8x247x3,2	Puccini-grafito	1	19,19
	Mesita de noche 2 cajones	53,8x44,6x33,5	Puccini-grafito	2	22,14
	Armario 3 puertas 2 cajones	207,6x130x50	Puccini-grafito	1	108,43

# DONALD DORMITORIO MATRIMONIO

## Cabecero matrimonio - 19,19 puntos

Nº bultos: 1

Medidas: 132x58,5x5 cm.

M3: 0,0386

KG: 22

Instrucciones montaje:

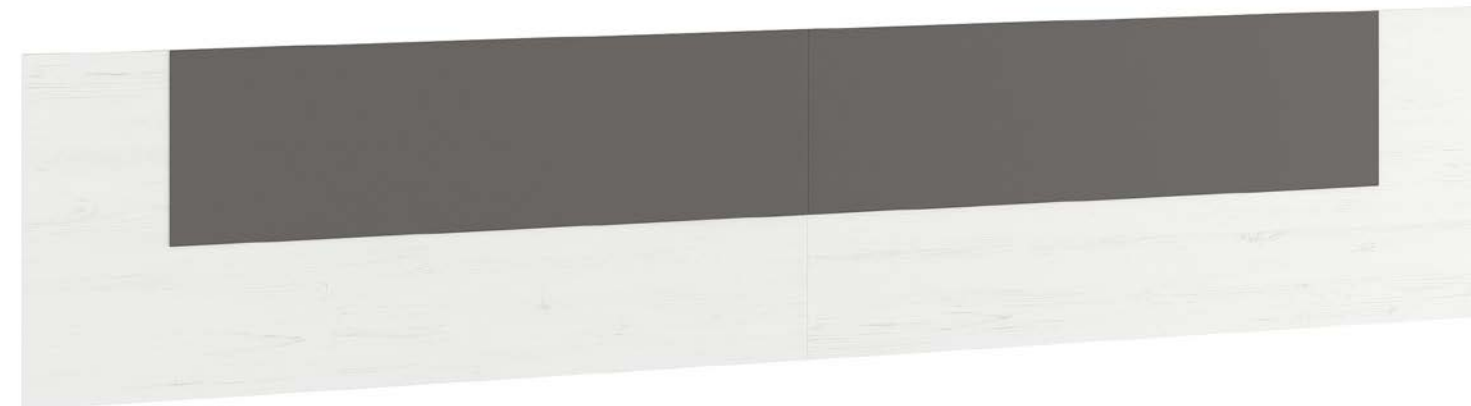

ANDERSEN-GRAFITO

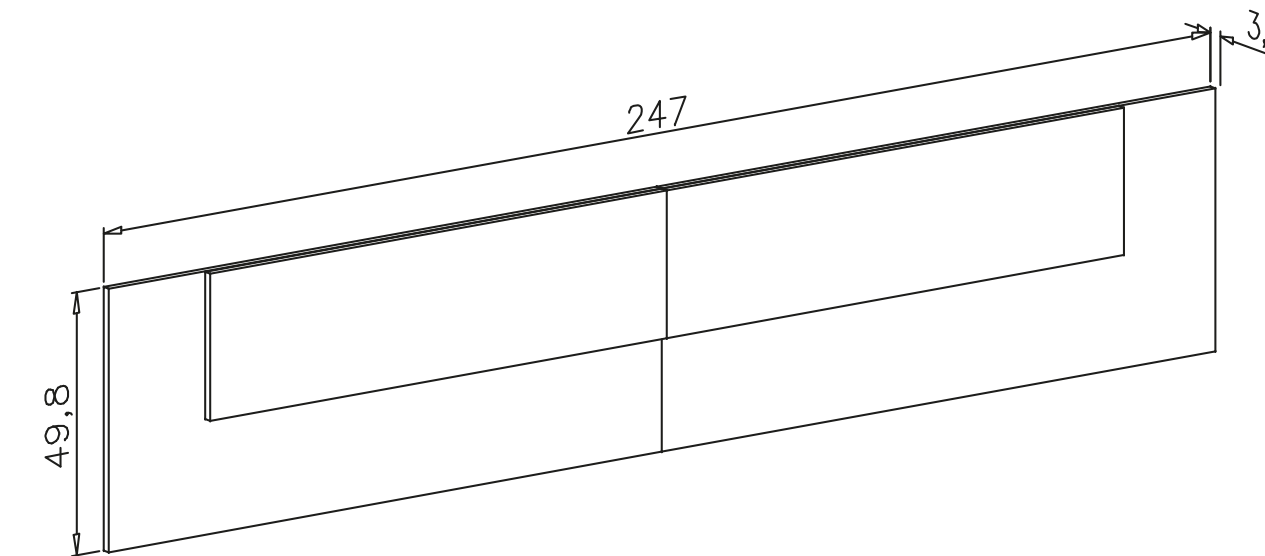

ANDERSEN-PUCINI



PUCINI-ANDERSEN



PUCINI-GRAFITO

## Mesita noche 2 cajones - 22,14 puntos

Nº bultos: 1

Medidas: 156x63x5 cm.

M3: 0,0397

KG: 22

Instrucciones montaje:

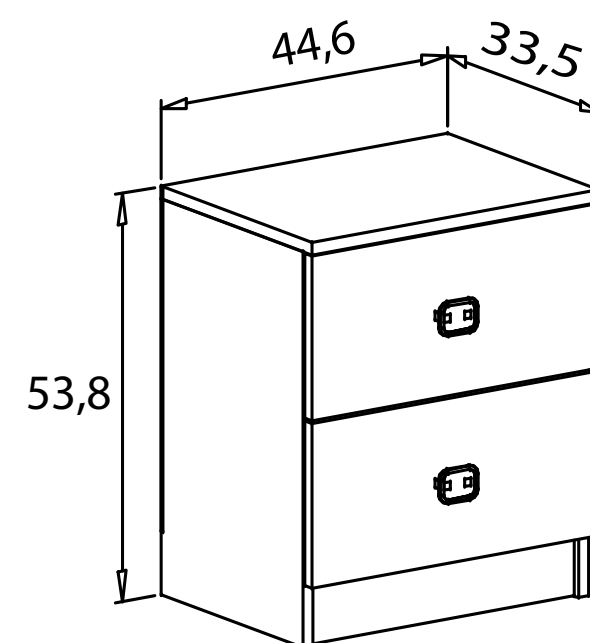

ANDERSEN-GRAFITO



ANDERSEN-PUCINI



PUCINI-ANDERSEN



PUCINI-GRAFITO

# DONALD DORMITORIO MATRIMONIO

## Sinfonier 5 cajones - 44,27 puntos

Nº bultos: 1

Medidas: 118x64x8 cm.

M3: 0,0604

KG: 30

Instrucciones montaje:

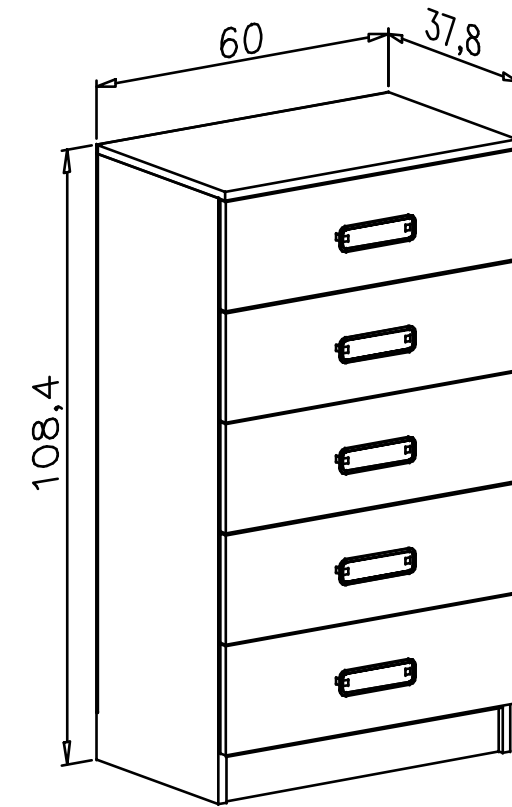

 ANDERSEN-GRAFITO



 ANDERSEN-PUCCINI



 PUCCINI-ANDERSEN



 PUCCINI-GRAFITO

## Armario 3 puertas 2 cajones - 108,03 puntos

Nº bultos: 3

Medidas 1/3: 149x52x9 cm.

Medidas 2/3: 217x52x5 cm.

Medidas 3/3: 209x47x7 cm.

M3: 0,1946

KG: 106

Instrucciones montaje:

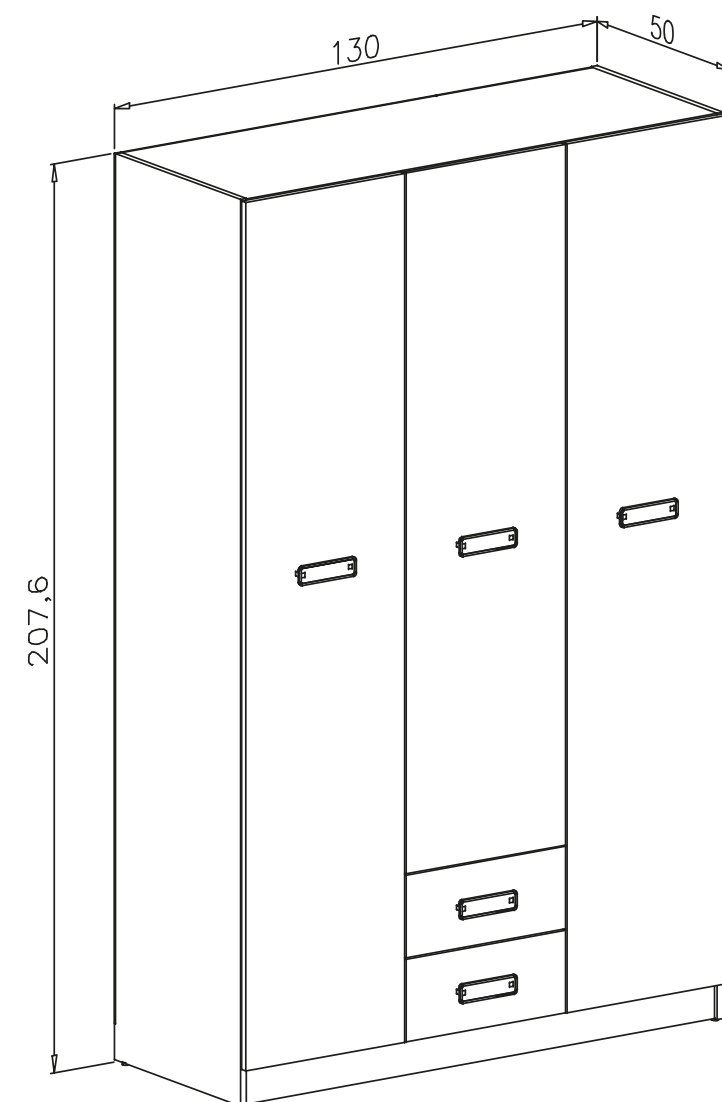

 ANDERSEN-GRAFITO



 ANDERSEN-PUCCINI



 PUCCINI-ANDERSEN



 PUCCINI-GRAFITO