



MODELO,
RUBÉN



MODELO RUBÉN

CARACTERÍSTICAS

- Estructura de madera de pino y aglomerado de 1ª calidad.
- Cincha respaldo 60 mm 60%.
- Cojines espuma aglomerado con muelles ensacados.
- Respaldos y brazos de goma espuma picada.
- Respaldos, brazos y cojín de asiento desenfundables.
- Patas delanteras de tubo cromadas 22x35 cm.

TAPIZADOS DISPONIBLES:

- NEVADA: 2 - 17
- CAIRO: antracita, beig oscuro, grafito y perla.
- MAGNOL*: cemento, piedra y plomo.
- EDI*: camel, marengo y plata.

TAPIZADO	PUNTOS
NEVADA	83,25
CAIRO	86,25
MAGNOL*	88,38
EDI*	91,75

VALOR DEL PUNTO OFERTA

Cemento



TELA MAGNOL*

Piedra



Plomo



Camel



TELA EDI*

Marengo



Plata



*Microfibra algodónada.

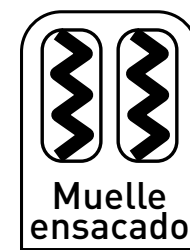
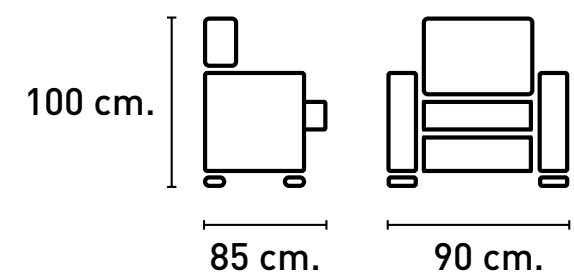

TELA NEVADA

2



17

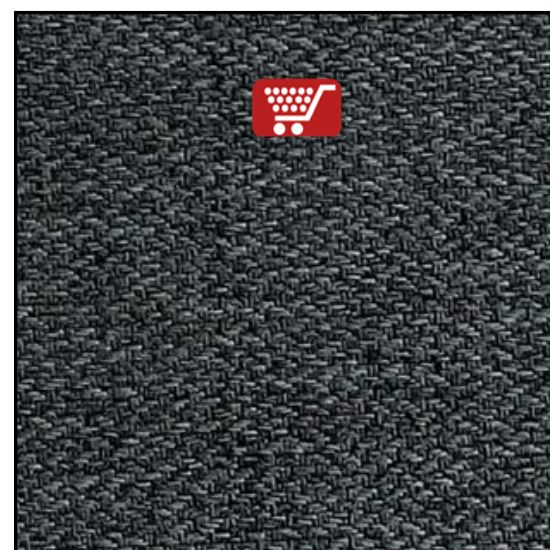

Antracita

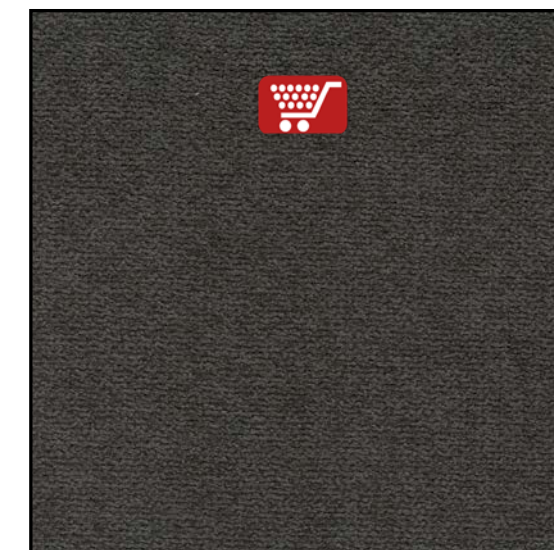

Beig oscuro



TELA CAIRO

Grafito

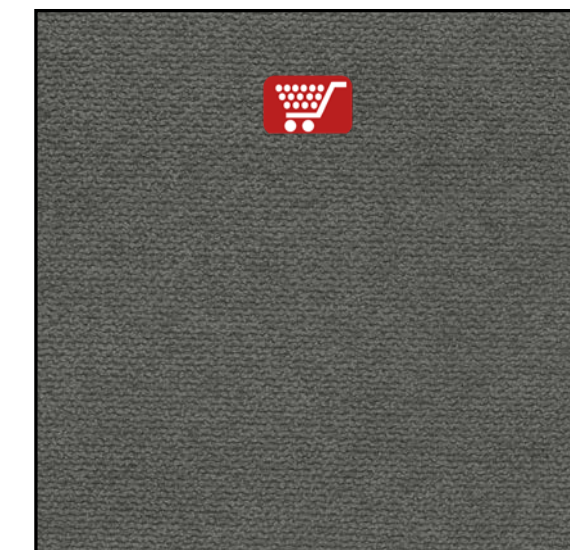

Perla

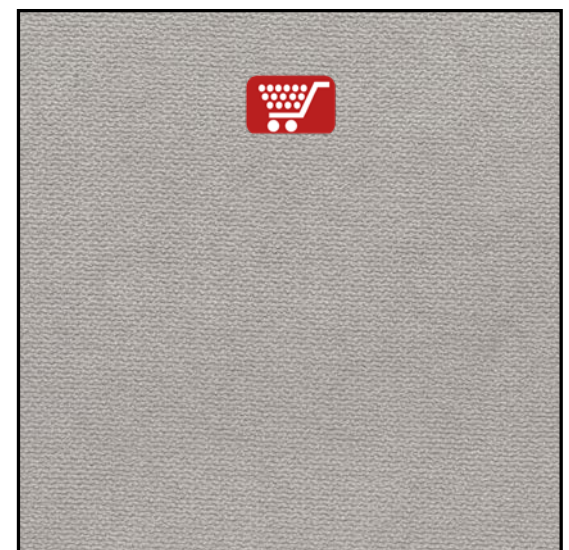

MODELO,
RUBÉN



MODELO RUBÉN

CARACTERÍSTICAS

- Estructura de madera de pino y aglomerado de 1ª calidad.
- Cincha asiento 80 mm 50% y cincha respaldo 60 mm 60%.
- Cojines espuma aglomerado con muelles ensacados.
- Respaldos y brazos de goma espuma picada.
- Respaldos, brazos y cojines de asientos desenfundables.
- Patas delanteras de tubo cromadas 22x35 cm.

TAPIZADOS DISPONIBLES:

- NEVADA: 2 - 17
- CAIRO: antracita, beig oscuro, grafito y perla.
- MAGNOL*: cemento, piedra y plomo.
- EDI*: camel, marengo y plata.

TAPIZADO EN STOCK:

- CAIRO: antracita y grafito.
- MAGNOL*: cemento y piedra.



actualizados puntos tela Cairo julio '24

TELA NEVADA

2



2PLAZAS 3PLAZAS

17

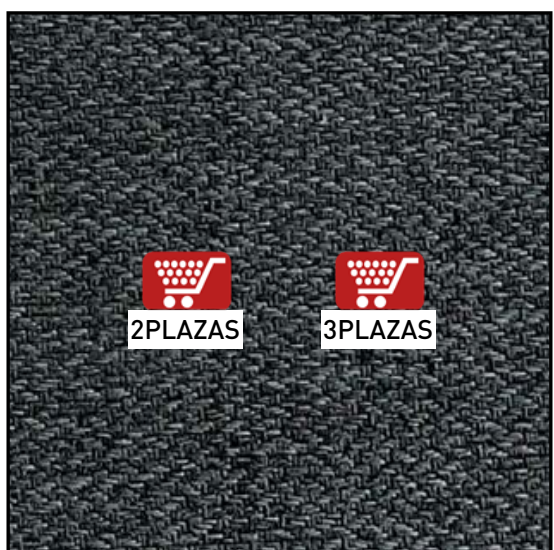

2PLAZAS 3PLAZAS

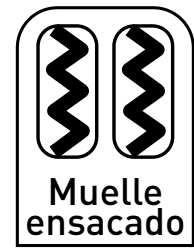
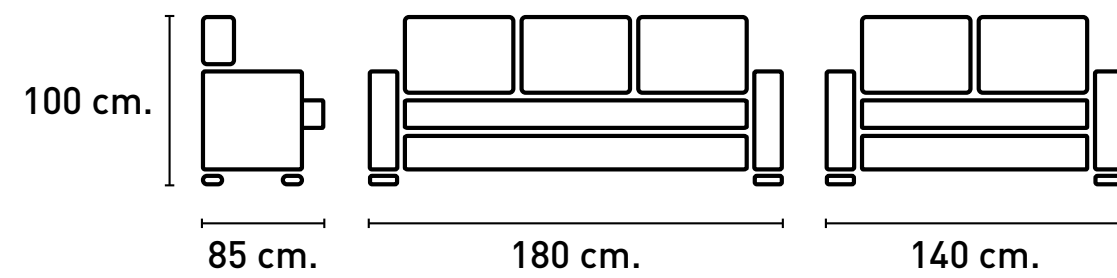

TAPIZADO	3 PLAZAS	2 PLAZAS	CONJUNTO 3+2
NEVADA	133,25	90,13	223,38
CAIRO	136,50	92,25	228,75
MAGNOL*	138,75	93,75	232,50
EDI*	140,00	94,63	234,63

VALOR DEL PUNTO OFERTA

Cemento



ENTREGA INMEDIATA

2PLAZAS 3PLAZAS

TELA MAGNOL*

Piedra



ENTREGA INMEDIATA

2PLAZAS 3PLAZAS

Plomo

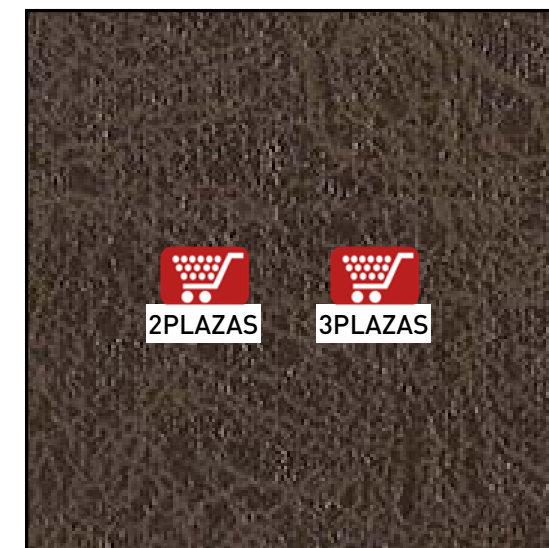

2PLAZAS 3PLAZAS

TELA CAIRO

Antracita



ENTREGA INMEDIATA

2PLAZAS 3PLAZAS

Beig oscuro

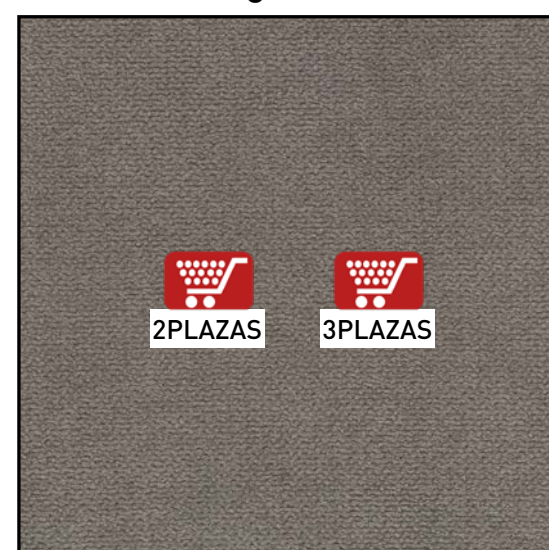

2PLAZAS 3PLAZAS

Grafito



ENTREGA INMEDIATA

2PLAZAS 3PLAZAS

Perla

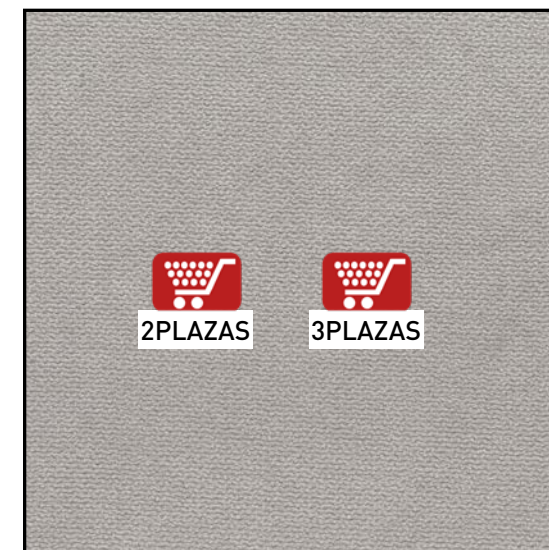

2PLAZAS 3PLAZAS

Camel



2PLAZAS 3PLAZAS

TELA EDI*

Marengo



2PLAZAS 3PLAZAS

Plata



2PLAZAS 3PLAZAS

*Microfibra algodónada.

MODELO,
RUBÉN



MODELO RUBÉN

CARACTERÍSTICAS

- Estructura de madera de pino y aglomerado de 1ª calidad.
- Cincha asiento 80 mm 50% y cincha respaldo 60 mm 60%.
- Cojines espuma aglomerado con muelles ensacados.
- Respaldos y brazos de goma espuma picada.
- Respaldos, brazos y cojines de asientos desenfundables.
- Patas delanteras de tubo cromadas 22x35 cm.

TAPIZADOS DISPONIBLES:

- NEVADA: 2 - 17
- CAIRO: antracita, beig oscuro, grafito y perla.
- MAGNOL*: cemento, piedra y plomo.
- EDI*: camel, plata y marengo.

actualizados puntos tela Cairo julio '24



TELA NEVADA

2

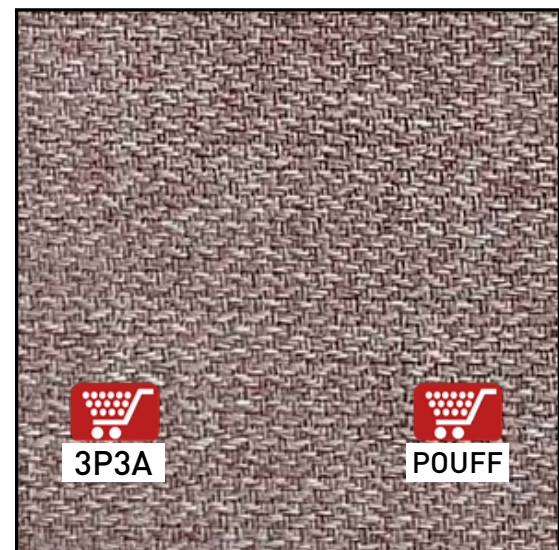

3P3A

POUFF

100 cm.

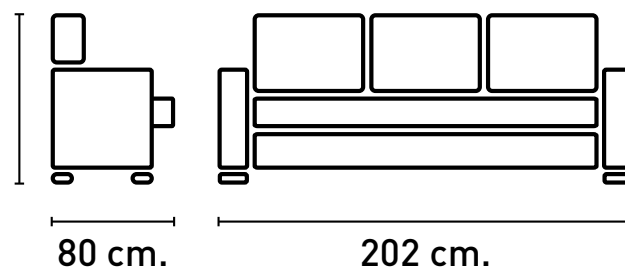

80 cm.

202 cm.

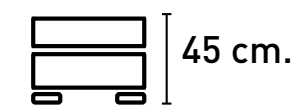

62x72 cm.

45 cm.

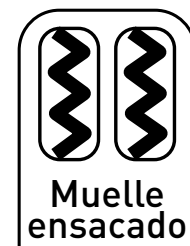

Muelle ensacado

TAPIZADO	3 PLAZAS 202CM.	POUFF	SHAIS. REVERSIBLE
NEVADA	148,13	47,50	195,63
CAIRO	151,25	48,50	199,75
MAGNOL*	155,63	51,38	207,01
EDI*	159,75	54,00	213,75

VALOR DEL PUNTO OFERTA

Cemento

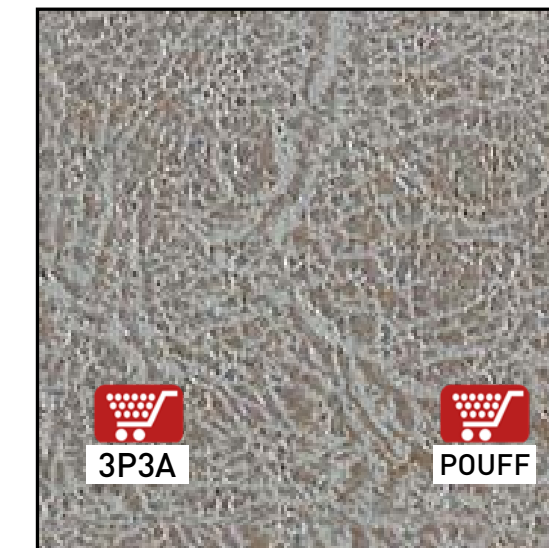

3P3A

POUFF

TELA MAGNOL*

Piedra

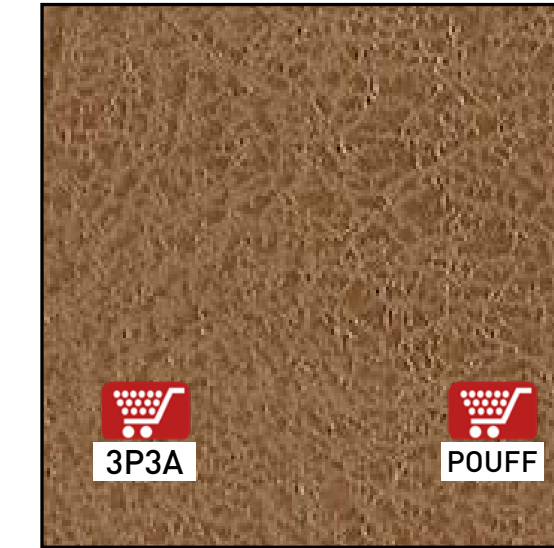

3P3A

POUFF

Plomo



3P3A

POUFF

17

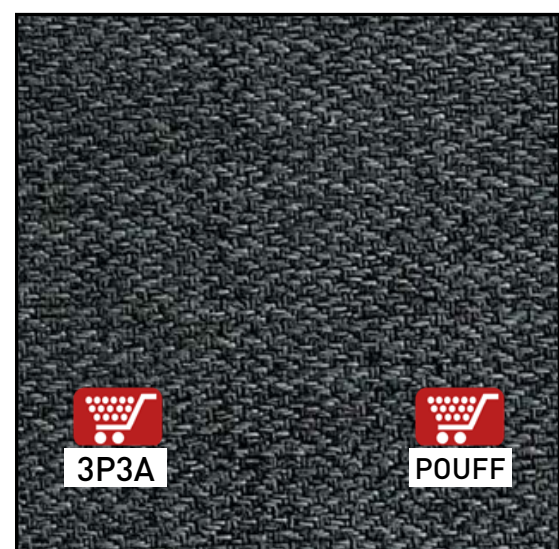

3P3A

POUFF

Antracita

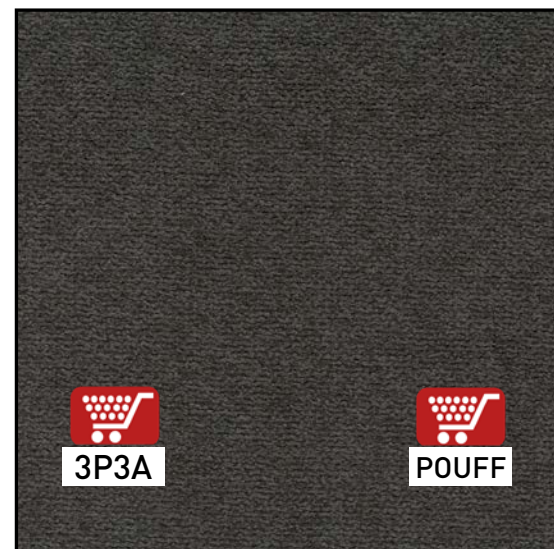

3P3A

POUFF

Beig oscuro

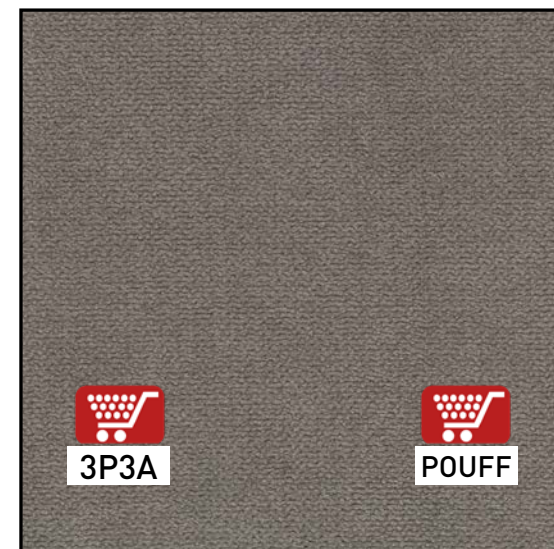

3P3A

POUFF

Grafito

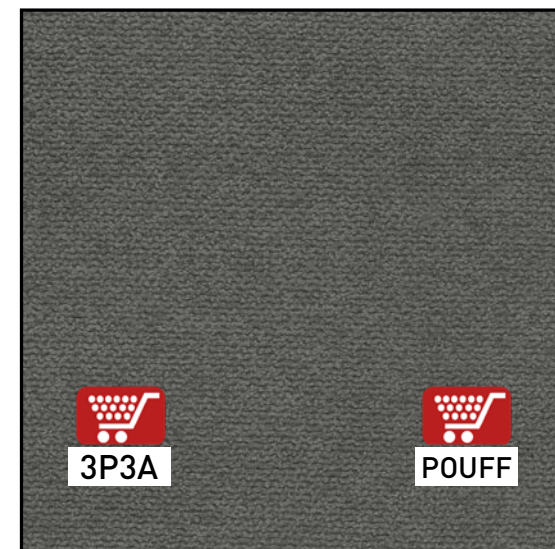

3P3A

POUFF

Perla

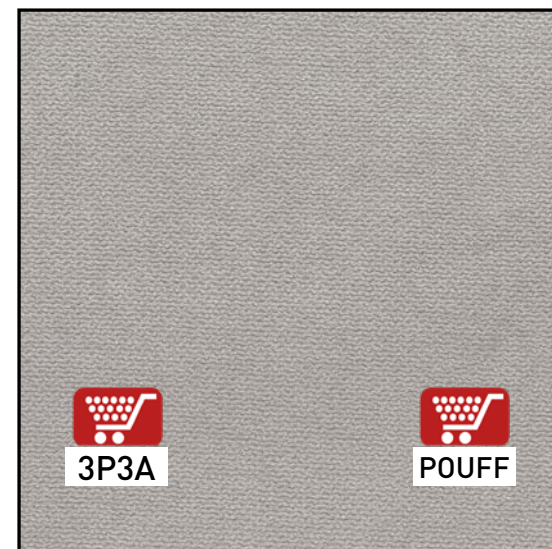

3P3A

POUFF

TELA CAIRO

Camel

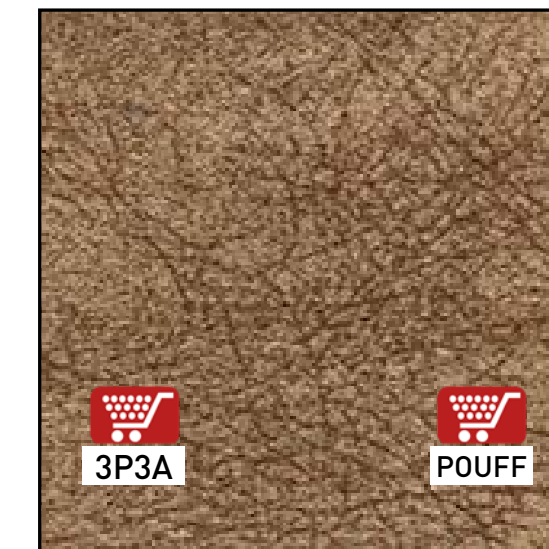

3P3A

POUFF

TELA EDI*

Marengo



3P3A

POUFF

Plata



3P3A

POUFF

*Microfibra algodónada.



MODELO, RUBÉN



Tapizado foto MAGNOL cemento.

MODELO RUBÉN

CARACTERÍSTICAS

- Estructura de madera de pino y aglomerado de 1ª calidad.
- Cincha asiento 80 mm 50% y cincha respaldo 60 mm 60%.
- Cojines espuma aglomerado con muelles ensacados.
- Respaldos y brazos de goma espuma picada.
- Respaldos, brazos y cojines de asientos desenfundables.
- Patas delanteras de tubo cromadas 22x35 cm.

TAPIZADOS DISPONIBLES:

- NEVADA: 2 - 17
- CAIRO: antracita, beig oscuro, grafito y perla.
- MAGNOL*: cemento, piedra y plomo.
- EDI*: camel, marengo y plata.

actualizados puntos tela Cairo julio '24



TELA NEVADA

2

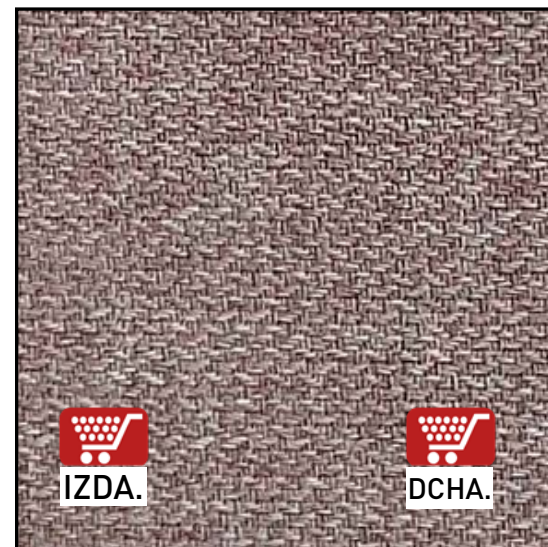

17

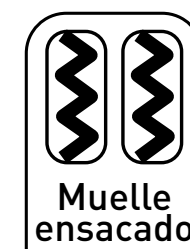
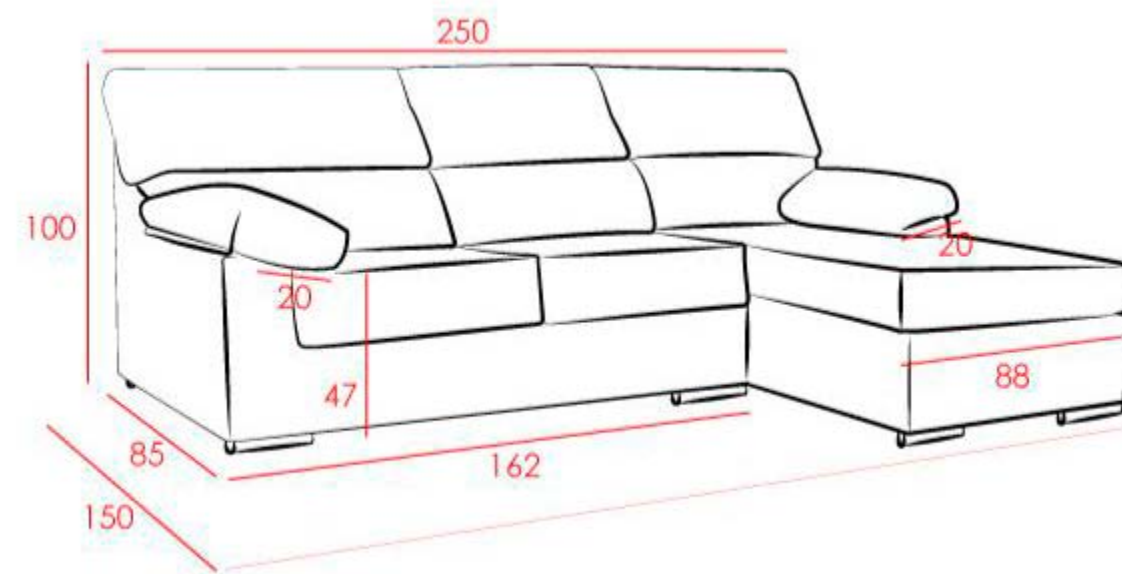

TAPIZADO	PUNTOS
NEVADA	230,00
CAIRO	234,50
MAGNOL*	245,63
EDI*	251,50

VALOR DEL PUNTO OFERTA

TELA MAGNOL*

Cemento

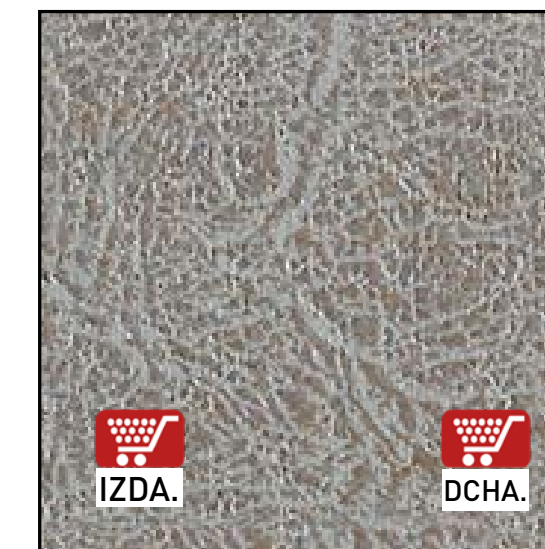

Piedra

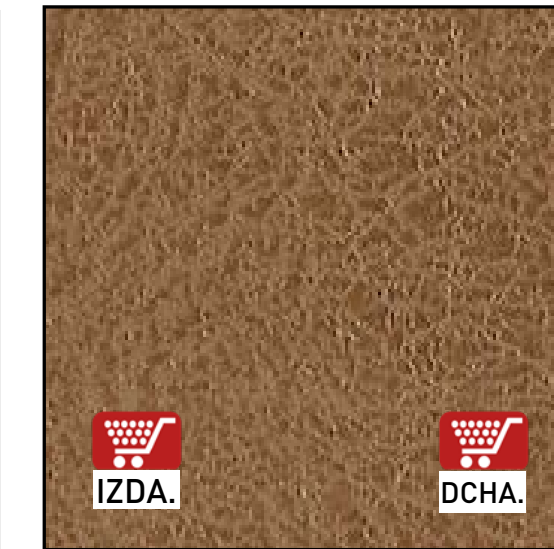

Plomo



TELA CAIRO

Antracita



Beig oscuro



Grafito

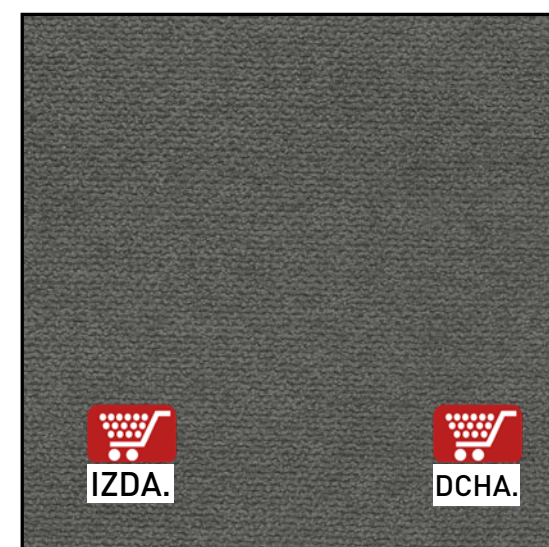

Perla

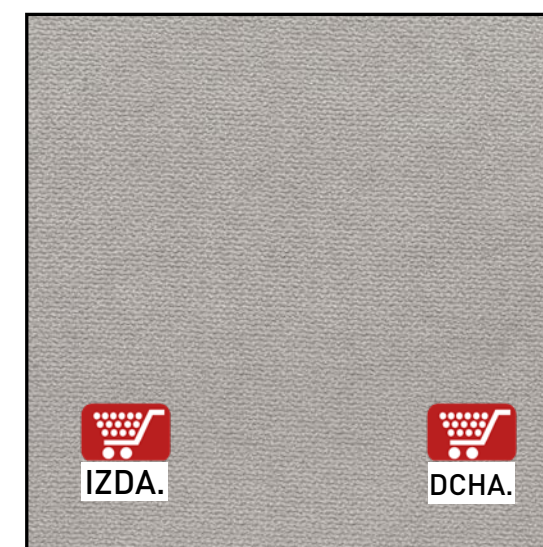

Camel



TELA EDI*

Marengo



Plata



*Microfibra algodónada.