



SOTO 22

NUEVOS PUNTOS MAYO 2023

NUEVA COLECCIÓN SALONES

SOTO 2 SALONES

Ambiente 01-A



COMPOSICIÓN APILABLE 180 CM.

64,16 puntos

	DESCRIPCIÓN	MEDIDAS	COLOR	UNID.	PUNTOS/ UNID.
	Alto 1 puerta	35,2x160x27,8	Puccini-textil	1	25,39
	Bajo TV 2 puertas	49x180x39,6	Puccini-textil	1	38,77

BLANCO-ROBLE



CAMBRIA-GRAFITO



PUCCINI-TEXTIL





SOTO 2 SALONES



Ambiente 01-B



 COMPOSICIÓN APILABLE 180 CM. 64,16 puntos

	DESCRIPCIÓN	MEDIDAS	COLOR	UNID.	PUNTOS/ UNID.
	Alto 1 puerta	35,2x160x27,8	Cambria-grafito	1	25,39
	Bajo TV 2 puertas	49x180x39,6	Cambria-grafito	1	38,77



Ambiente 01-C

 COMPOSICIÓN APILABLE 180 CM. 64,16 puntos

	DESCRIPCIÓN	MEDIDAS	COLOR	UNID.	PUNTOS/ UNID.
	Alto 1 puerta	35,2x160x27,8	Blanco-roble	1	25,39
	Bajo TV 2 puertas	49x180x39,6	Blanco-roble	1	38,77

SOTO 2 SALONES

Ambiente 02-A

VITRINA 81,27 puntos



DESCRIPCIÓN	MEDIDAS	COLOR	UNID.	PUNTOS/ UNID.
 Vitrina	156x120,9x39,6	Puccini-textil	1	81,27

BLANCO-ROBLE



CAMBRIA-GRAFITO



PUCCINI-TEXTIL



SOTO 2 SALONES



Ambiente 02-B

VITRINA 81,27 puntos

DESCRIPCIÓN	MEDIDAS	COLOR	UNID.	PUNTOS/ UNID.
 Vitrina	156x120,9x39,6	Cambria-grafito	1	81,27



Ambiente 02-C

VITRINA 81,27 puntos

DESCRIPCIÓN	MEDIDAS	COLOR	UNID.	PUNTOS/ UNID.
 Vitrina	156x120,9x39,6	Blanco-roble	1	81,27

SOTO 2 SALONES

Ambiente 03-A

ESTANTERÍA 39,91 puntos



DESCRIPCIÓN	MEDIDAS	COLOR	UNID.	PUNTOS/ UNID.
 Estantería	174x129x32,8	Puccini-textil	1	39,91

BLANCO-ROBLE



CAMBRIA-GRAFITO



PUCCINI-TEXTIL



SOTO 2 SALONES



Ambiente 03-B

ESTANTERÍA 39,91 puntos

DESCRIPCIÓN	MEDIDAS	COLOR	UNID.	PUNTOS/ UNID.
 Estantería	174x129x32,8	Cambria-grafito	1	39,91



Ambiente 03-C



ESTANTERÍA 39,91 puntos

DESCRIPCIÓN	MEDIDAS	COLOR	UNID.	PUNTOS/ UNID.
 Estantería	174x129x32,8	Blanco-roble	1	39,91

SOTO 2 SALONES

Ambiente 04-A

 COMPOSICIÓN APILABLE 180 CM. 55,87 puntos

	DESCRIPCIÓN	MEDIDAS	COLOR	UNID.	PUNTOS/ UNID.
	Estante L	13x91,5x17,6	Puccini	2	8,55
	Bajo TV 2 puertas	49x180x39,6	Puccini-textil	1	38,77

BLANCO-ROBLE



CAMBRIA-GRAFITO



PUCCINI-TEXTIL





SOTO 2 SALONES



Ambiente 04-B



 COMPOSICIÓN APILABLE 180 CM. 55,87 puntos

DESCRIPCIÓN	MEDIDAS	COLOR	UNID.	PUNTOS/ UNID.
 Estante L	13x91,5x17,6	Cambria	2	8,55
 Bajo TV 2 puertas	49x180x39,6	Cambria-grafito	1	38,77



Ambiente 04-C





 COMPOSICIÓN APILABLE 180 CM. 55,87 puntos

DESCRIPCIÓN	MEDIDAS	COLOR	UNID.	PUNTOS/ UNID.
 Estante L	13x91,5x17,6	Blanco	2	8,55
 Bajo TV 2 puertas	49x180x39,6	Blanco-roble	1	38,77

SOTO 2 SALONES

Ambiente 05-A

 **SALÓN COMPLETO** 177,05 puntos

DESCRIPCIÓN	MEDIDAS	COLOR	UNID.	PUNTOS/ UNID.
 Estante L	13x91,5x17,6	Puccini	2	8,55
 Bajo TV 2 puertas	49x180x39,6	Puccini-textil	1	38,77
 Estantería	174x129x32,8	Puccini-textil	1	39,91
 Vitrina	156x120,9x39,6	Puccini-textil	1	81,27

BLANCO-ROBLE

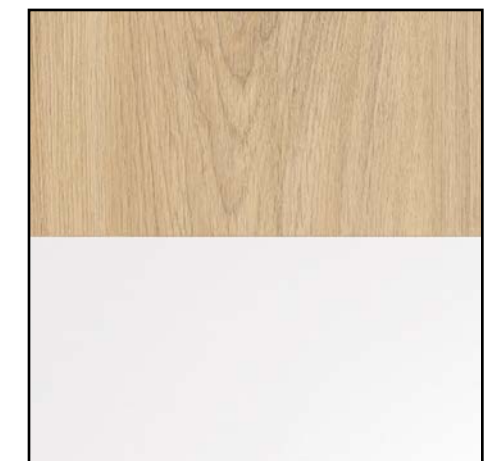

CAMBRIA-GRAFITO



PUCCINI-TEXTIL







SOTO 2 SALONES



Ambiente 05-B





 **SALÓN COMPLETO** 177,05 puntos

DESCRIPCIÓN	MEDIDAS	COLOR	UNID.	PUNTOS/ UNID.
 Estante L	13x91,5x17,6	Cambria	2	8,55
 Bajo TV 2 puertas	49x180x39,6	Cambria-grafito	1	38,77
 Estantería	174x129x32,8	Cambria-grafito	1	39,91
 Vitrina	156x120,9x39,6	Cambria-grafito	1	81,27



Ambiente 05-C

 **SALÓN COMPLETO** 177,05 puntos

DESCRIPCIÓN	MEDIDAS	COLOR	UNID.	PUNTOS/ UNID.
 Estante L	13x91,5x17,6	Blanco	2	8,55
 Bajo TV 2 puertas	49x180x39,6	Blanco-roble	1	38,77
 Estantería	174x129x32,8	Blanco-roble	1	39,91
 Vitrina	156x120,9x39,6	Blanco-roble	1	81,27

SOTO 2 SALONES

Ambiente 06-A

APARADOR 44,19 puntos

DESCRIPCIÓN	MEDIDAS	COLOR	UNID.	PUNTOS/ UNID.
 Aparador	70x138x39,5	Puccini-textil	1	44,19



BLANCO-ROBLE



ROBLE-GRAFITO



PUCCINI-TEXTIL



SOTO 2 SALONES



Ambiente 06-B

APARADOR 44,19 puntos

DESCRIPCIÓN	MEDIDAS	COLOR	UNID.	PUNTOS/ UNID.
 Aparador	70x138x39,5	Roble-grafito	1	44,19



Ambiente 06-C

APARADOR 44,19 puntos

DESCRIPCIÓN	MEDIDAS	COLOR	UNID.	PUNTOS/ UNID.
 Aparador	70x138x39,5	Blanco-roble	1	44,19

SOTO 2 SALONES

Ambiente 07

MUEBLE BAR 39,77 puntos





PUCINI-TEXTIL



CAMBRIA-GRAFITO





BLANCO-ROBLE

	DESCRIPCIÓN	MEDIDAS	COLOR	UNID.	PUNTOS/ UNID.
	Mueble bar	135x60x39,6	Puccini-textil	1	39,77
	Mueble bar	135x60x39,6	Cambria-grafito	1	39,77
	Mueble bar	135x60x39,6	Blanco-roble	1	39,77

SOTO 2 SALONES

Ambiente 08-A

 **SALÓN COMPLETO** 143,84 puntos

DESCRIPCIÓN	MEDIDAS	COLOR	UNID.	PUNTOS/ UNID.
 Alto 1 puerta	35,2x160x27,8	Puccini-textil	1	25,39
 Bajo TV 2 puertas	49x180x39,6	Puccini-textil	1	38,77
 Estantería	174x129x32,8	Puccini-textil	1	39,91
 Mueble bar	135x60x39,6	Puccini-textil	1	39,77

BLANCO-ROBLE

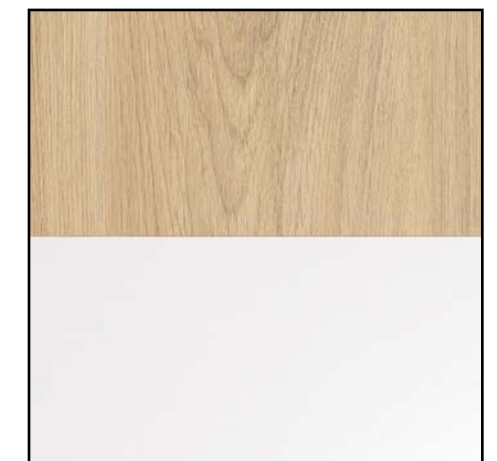

CAMBRIA-GRAFITO



PUCCINI-TEXTIL







SOTO 2 SALONES



Ambiente 08-B





 **SALÓN COMPLETO** 143,84 puntos

	DESCRIPCIÓN	MEDIDAS	COLOR	UNID.	PUNTOS/ UNID.
	Alto 1 puerta	35,2x160x27,8	Cambria-grafito	1	25,39
	Bajo TV 2 puertas	49x180x39,6	Cambria-grafito	1	38,77
	Estantería	174x129x32,8	Cambria-grafito	1	39,91
	Mueble bar	135x60x39,6	Cambria-grafito	1	39,77



Ambiente 08-C

 **SALÓN COMPLETO** 143,84 puntos

	DESCRIPCIÓN	MEDIDAS	COLOR	UNID.	PUNTOS/ UNID.
	Alto 1 puerta	35,2x160x27,8	Blanco-roble	1	25,39
	Bajo TV 2 puertas	49x180x39,6	Blanco-roble	1	38,77
	Estantería	174x129x32,8	Blanco-roble	1	39,91
	Mueble bar	135x60x39,6	Blanco-roble	1	39,77

SOTO 2 SALONES

Instrucciones montaje:

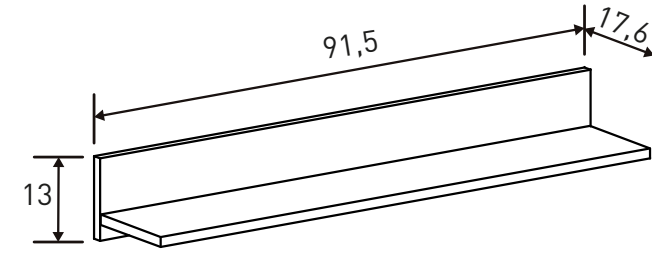

ESTANTE L - 8,55 puntos

Cambria



Blanco



Puccini



Nº bultos: 1
Medidas: 98x19,5x4,5 cm.
M3: 0,0086
KG: 4

Instrucciones montaje:

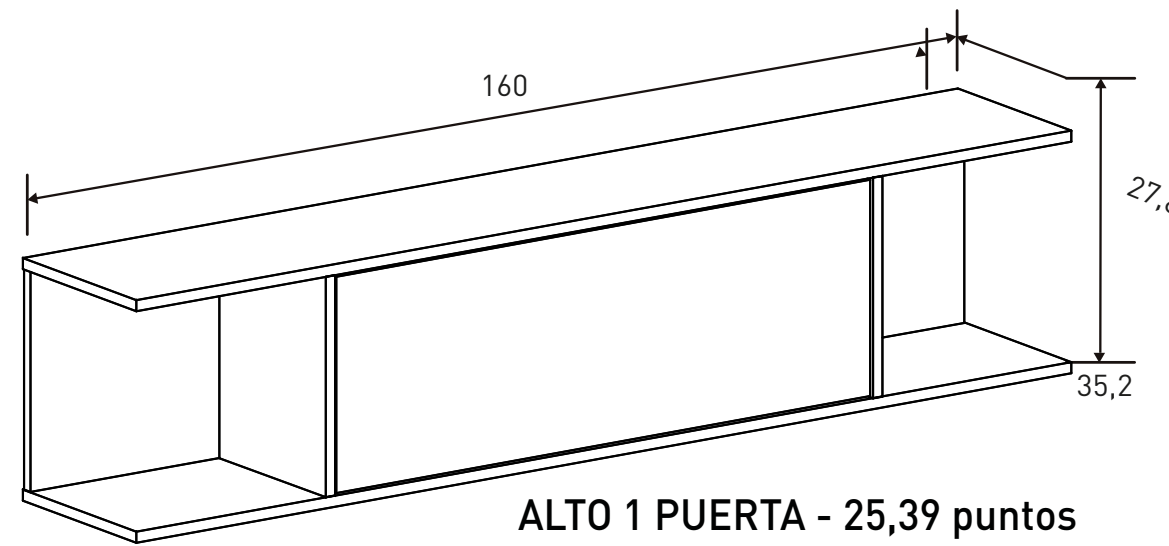

ALTO 1 PUERTA - 25,39 puntos

Cambria-grafito



Blanco-roble



Puccini-textil



Nº bultos: 1
Medidas: 176x36x7 cm.
M3: 0,0444
KG: 22

Instrucciones montaje:

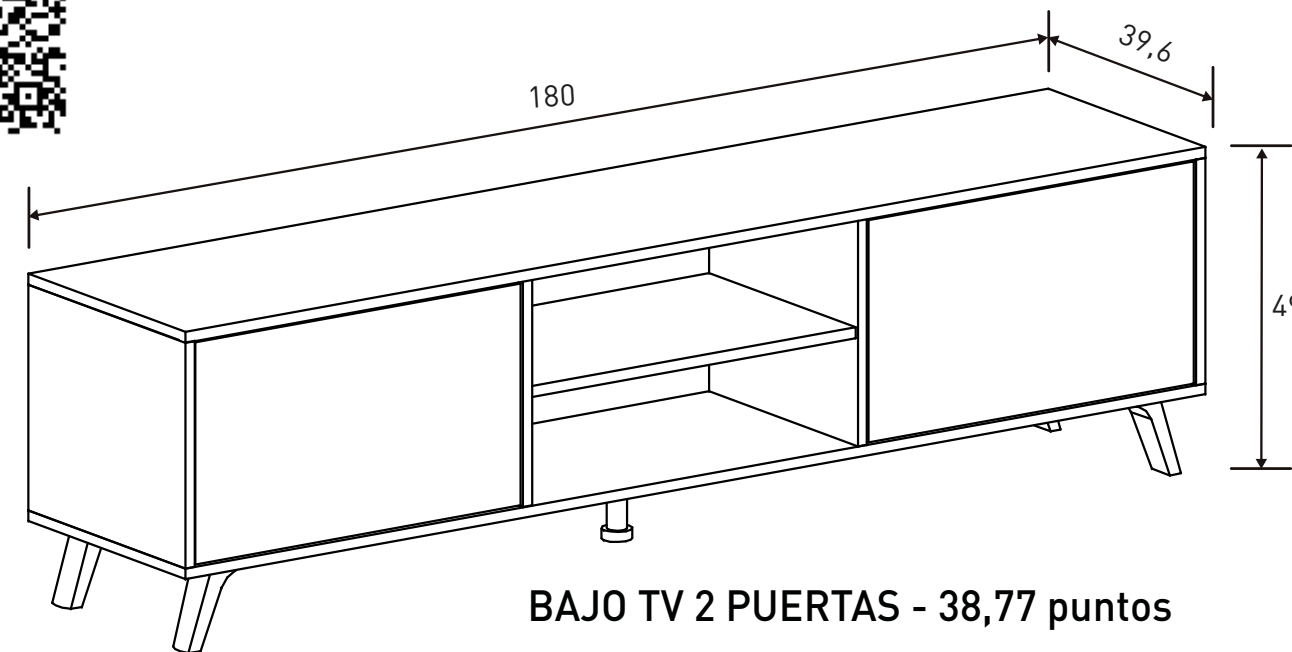

BAJO TV 2 PUERTAS - 38,77 puntos

Cambria-grafito



Blanco-roble



Puccini-textil



Nº bultos: 1
Medidas: 200x42,5x7 cm.
M3: 0,0595
KG: 33

Instrucciones montaje:

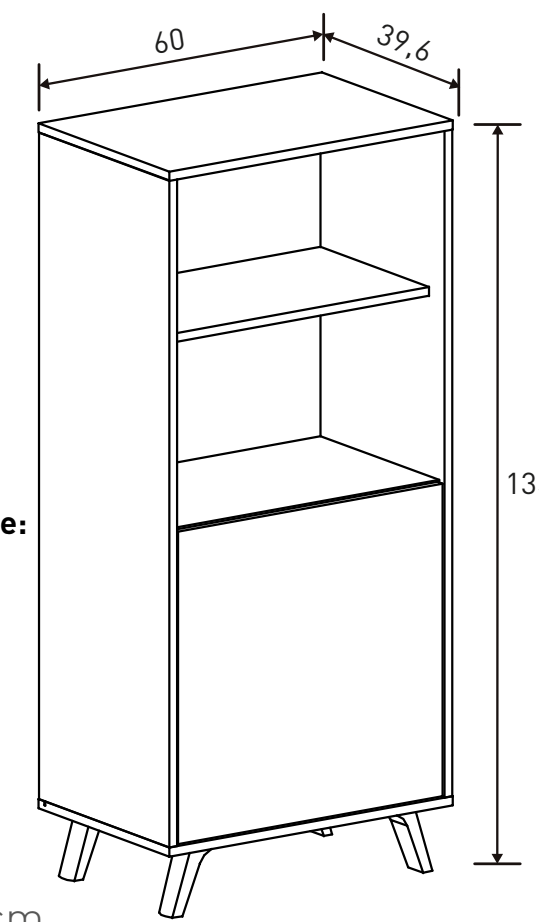

MUEBLE BAR - 39,77 puntos

Cambria-grafito



Blanco-roble



Puccini-textil



Nº bultos: 1
Medidas: 128x61,5x9,5 cm.
M3: 0,0748
KG: 31

Instrucciones montaje:

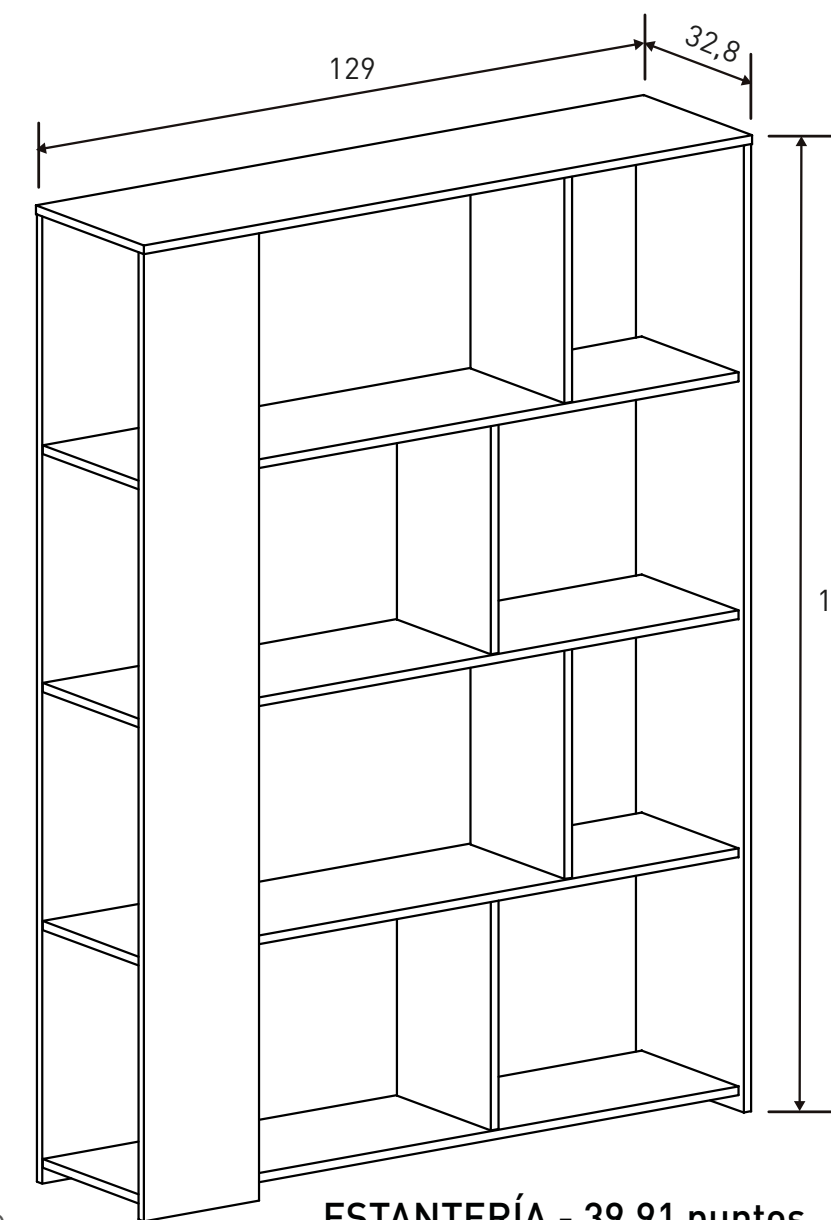

ESTANTERÍA - 39,91 puntos

Cambria-grafito



Blanco-roble



Puccini-textil



Nº bultos: 2
Medidas 1/2: 144x36,5x9 cm.
Medidas 2/2: 181x36,5x7,5 cm.
M3: 0,0969
KG: 47

Nº bultos: 1
Medidas: 12x145x48 cm.
M3: 0,0835
KG: 40

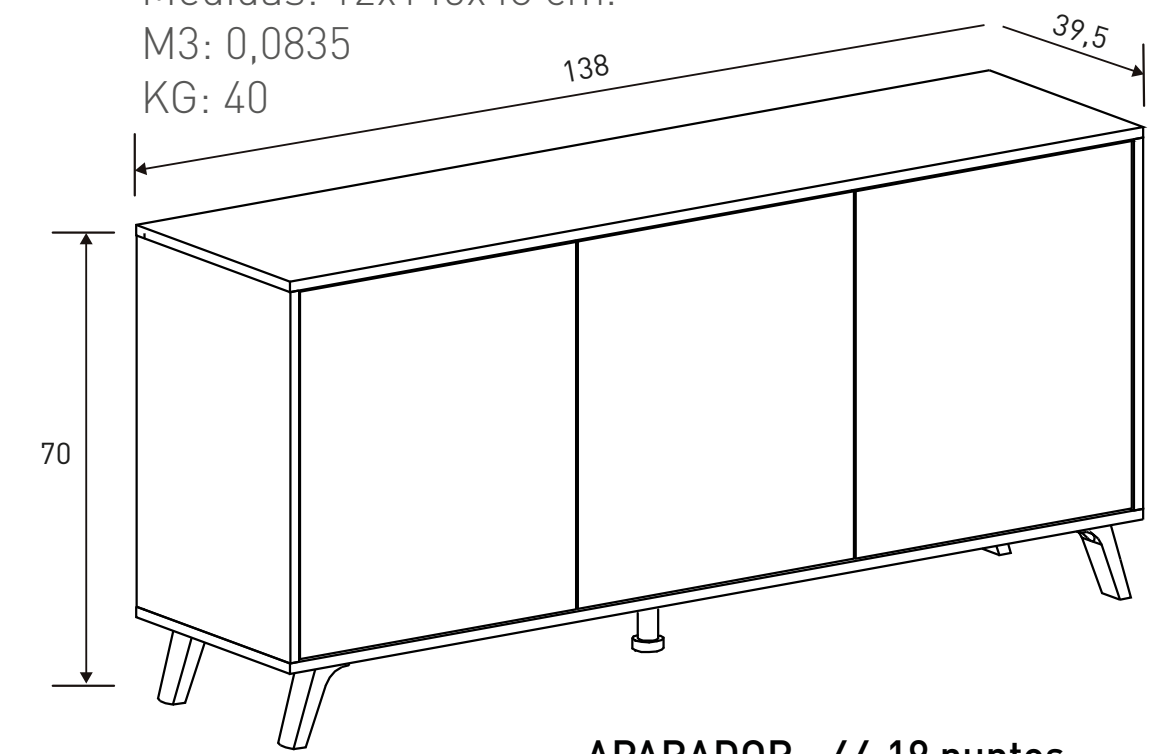

APARADOR - 44,19 puntos

Roble-grafito



Blanco-roble



Puccini-textil



Instrucciones montaje:

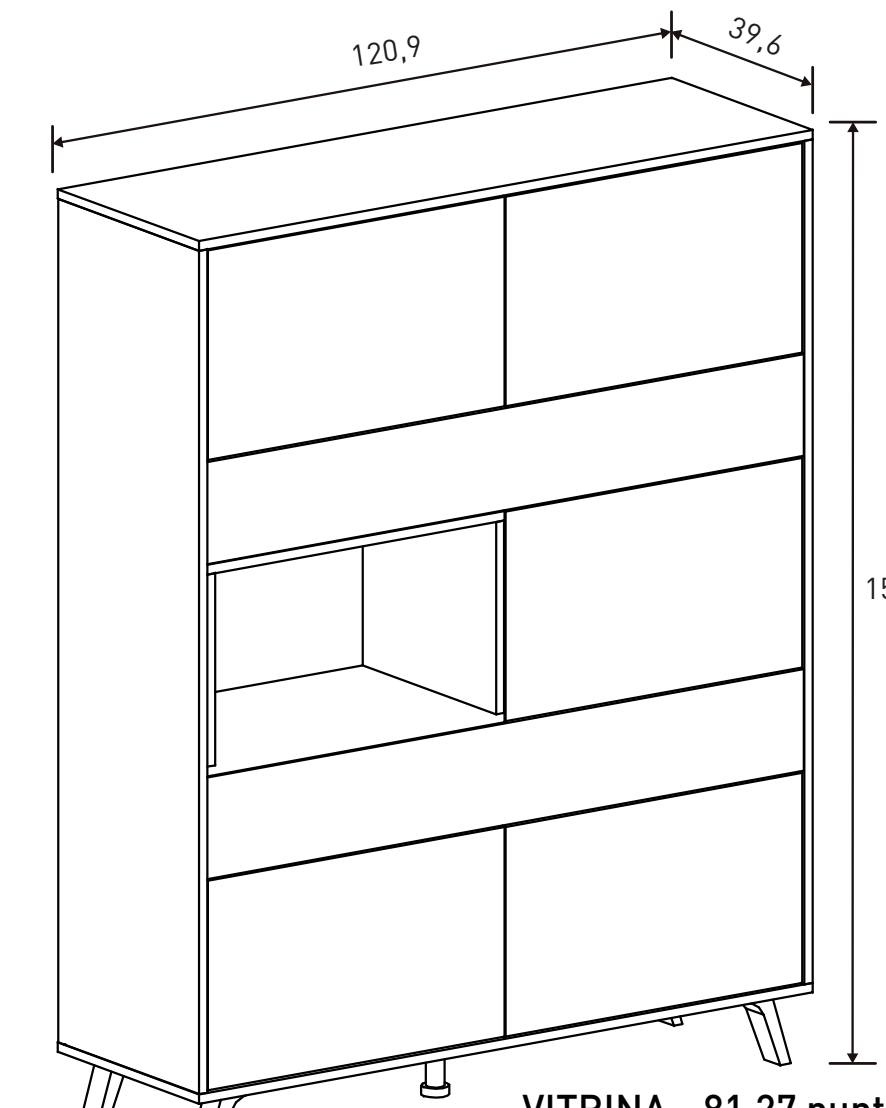

VITRINA - 81,27 puntos

Cambria-grafito



Blanco-roble



Puccini-textil



Instrucciones montaje:



Nº bultos: 2
Medidas 1/2: 146x42,5x11,5 cm.
Medidas 2/2: 126x42,5x13 cm.
M3: 0,141
KG: 79



SOTO 2

Instrucciones montaje TODO EL CATÁLOGO:



NUEVOS PUNTOS MAYO 2023

NUEVA COLECCIÓN SALONES