

MODELO
UVE



MODELO UVE



CARACTERÍSTICAS

- Asientos extraíbles y respaldos reclinables.
- Cojines espuma densidad 25 kg. con muelles ensacados.
- Respaldos y riñoneras mezcla (picado-floca).
- Brazos siesta.

TAPIZADOS DISPONIBLES:

- NEVADA: 2 - 17
- CAIRO: antracita, beig oscuro, grafito y perla.
- MAGNOL*: cemento, piedra y plomo.
- EDI*: camel, marengo y plata.

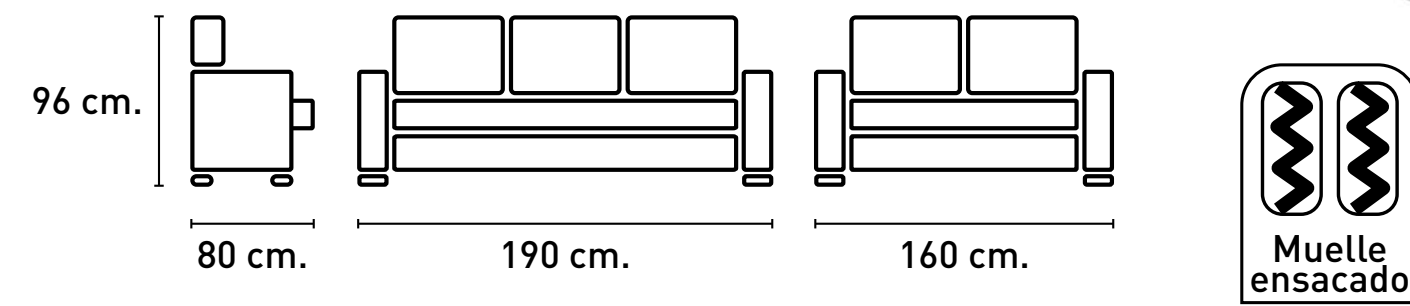

TELA NEVADA

2

17

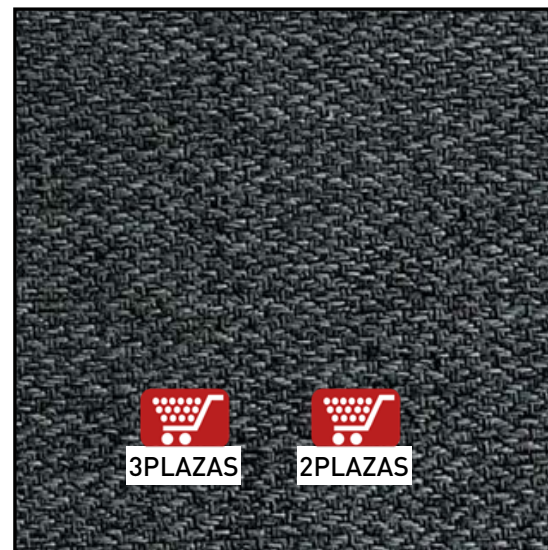
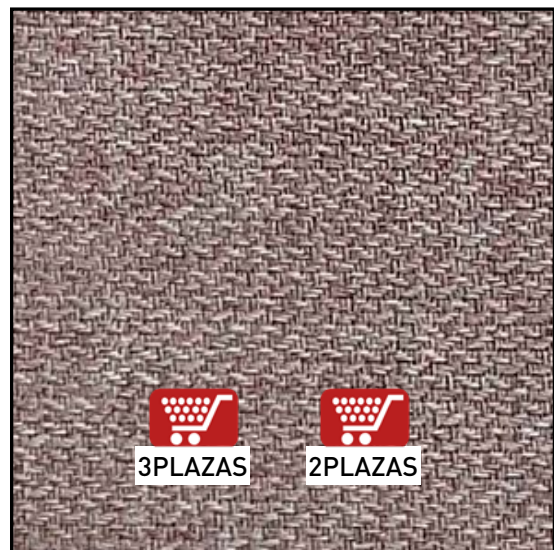

TAPIZADO	3 PLAZAS	2 PLAZAS	CONJUNTO 3+2
NEVADA	180,99	151,89	332,88
CAIRO	185,30	155,30	340,60
MAGNOL*	188,43	158,30	346,73
EDI*	190,18	159,80	349,98

VALOR DEL PUNTO OFERTA

TELA MAGNOL*

Cemento

Piedra

Plomo

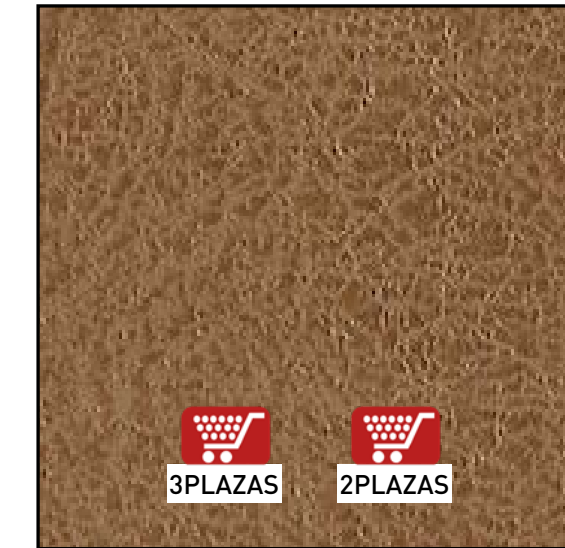
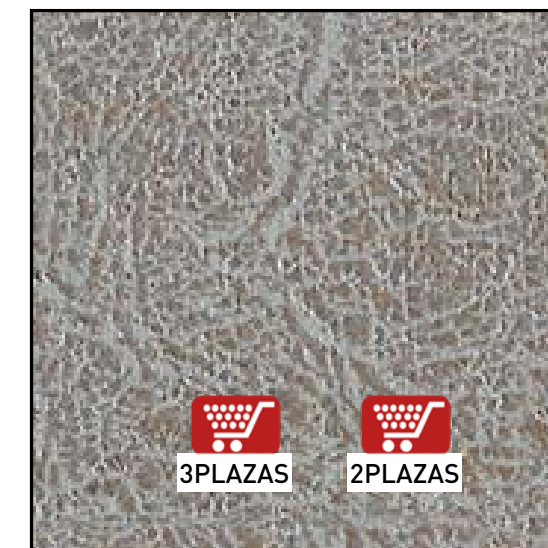

TELA CAIRO

Antracita

Beig oscuro

Grafito

Perla

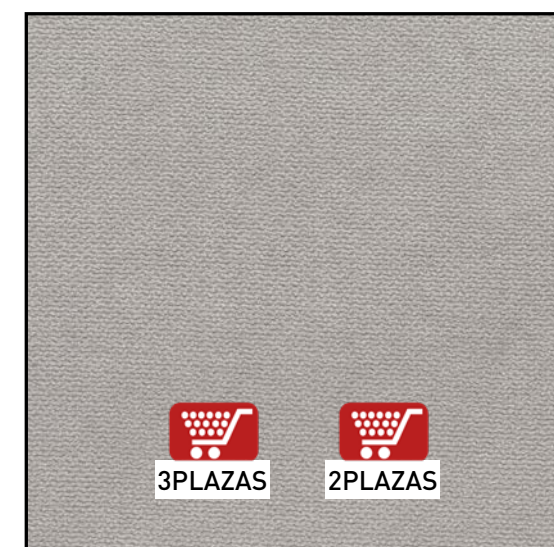
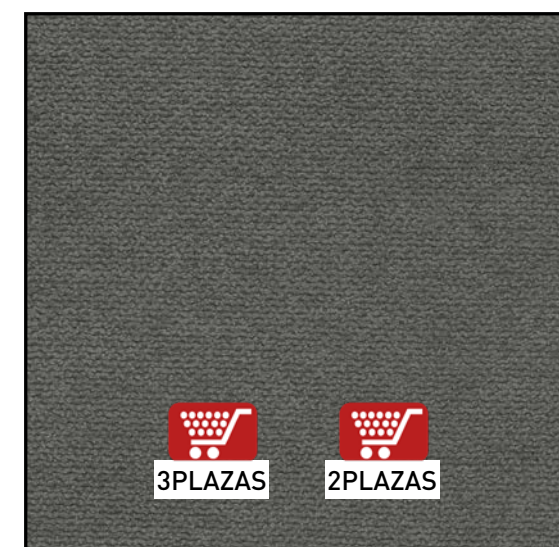
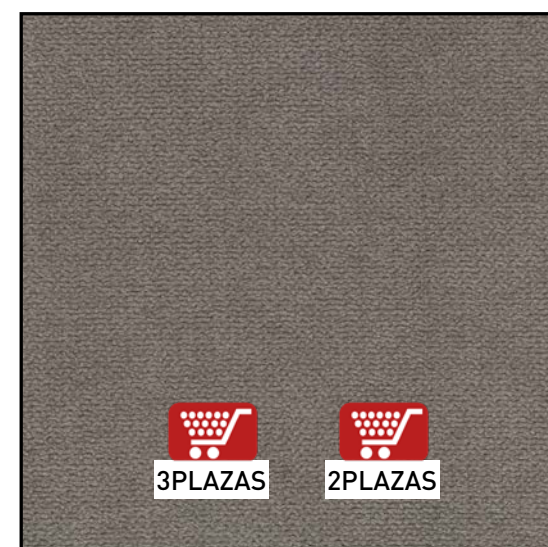

TELA EDI*

Antracita

Camel

Marengo

Plata

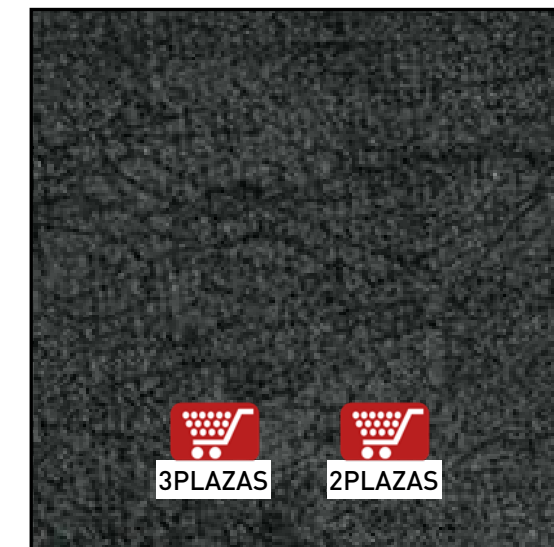

*Microfibra algodónada.

MODELO UVE

CARACTERÍSTICAS

- Asientos extraíbles y respaldos reclinables.
- Cojines espuma densidad 25 kg. con muelles ensacados.
- Respaldos y riñoneras mezcla (picado-floca).
- Brazos siesta.

TAPIZADOS DISPONIBLES:

- NEVADA: 2 - 17
- CAIRO: antracita, beig oscuro, grafito y perla.
- MAGNOL*: cemento, piedra y plomo.
- EDI*: camel, marengo y plata.

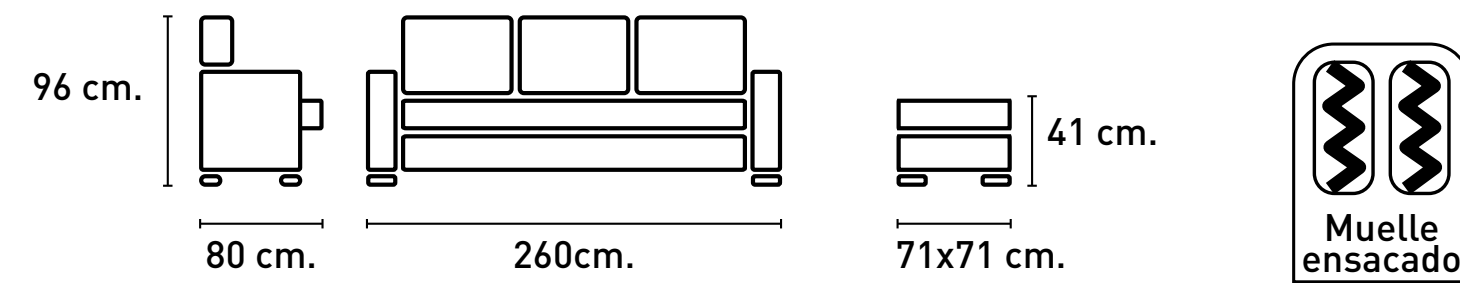

TAPIZADO	3 PLAZAS 202CM.	POUFF	SHAIS. REVERSIBLE
NEVADA	269,26	52,81	322,07
CAIRO	275,00	53,75	328,75
MAGNOL*	279,40	54,38	333,78
EDI*	281,60	54,69	336,29

VALOR DEL PUNTO OFERTA

TELA NEVADA

2

17



TELA MAGNOL*

Cemento

Piedra

Plomo

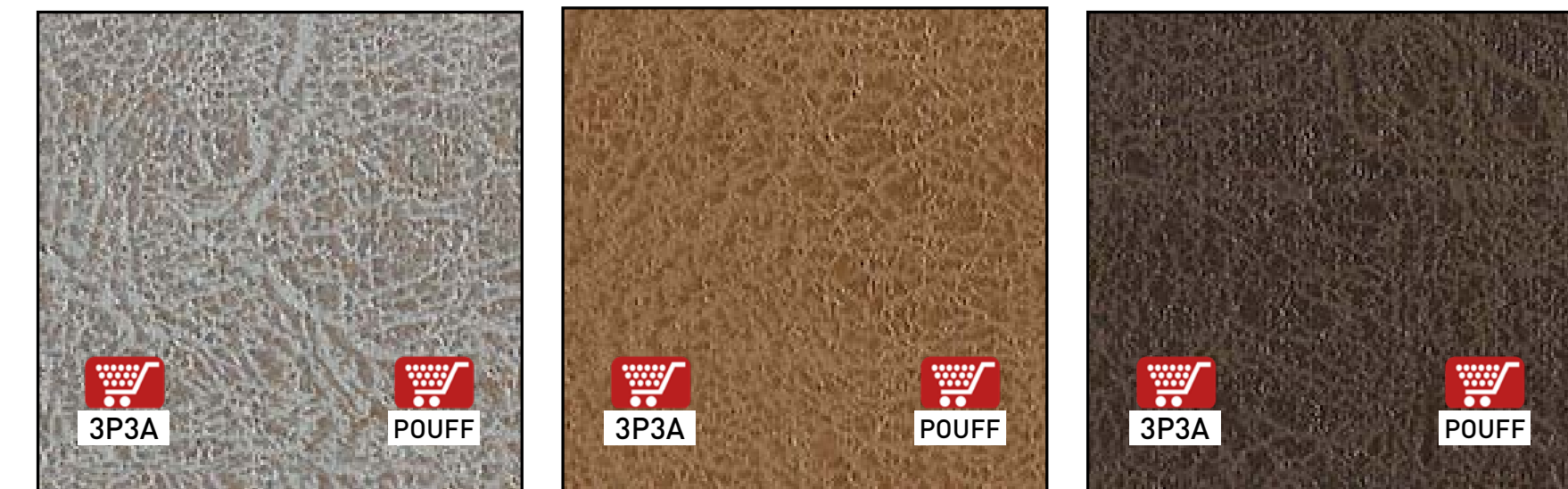

TELA CAIRO

Antracita

Beig oscuro

Grafito

Perla

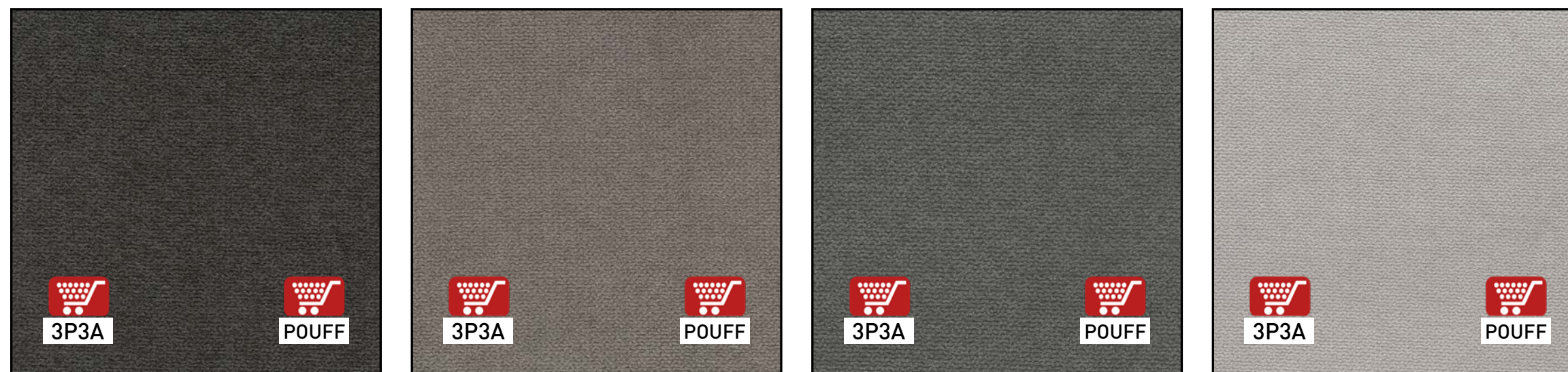

TELA EDI*

Antracita

Camel

Marengo

Plata



*Microfibra algodónada.